

General Description

TRinno IGBT power module provides low conduction & switching loss as well as short circuit ruggedness. It is designed for applications such as Motor Driver, IH & Rectifier applications.

Features

- 1200V NPT Trench Technology
- Fast & Soft inverse Diodes
- Positive Temperature Coefficient
- Short Circuit Withstanding Time 10 μ s
- UL certified, file No. E490086

Applications

Motor driver, IH(Induction heating), Rectifier, Welder

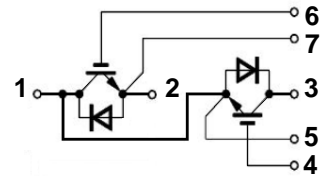

Absolute Maximum Ratings

Parameter	Symbol	Value	Unit	
Collector-Emitter Voltage	V_{CES}	1200	V	
Gate-Emitter Voltage	V_{GES}	± 20	V	
Continuous Collector Current	I_C	$T_C = 25\text{ }^\circ\text{C}$	300	A
		$T_C = 100\text{ }^\circ\text{C}$	150	A
Pulsed Collector Current (Note 1)	I_{CM}	300	A	
Diode Continuous Forward Current	I_F	88	A	
Power Dissipation	P_D	$T_C = 25\text{ }^\circ\text{C}$	625	W
		$T_C = 100\text{ }^\circ\text{C}$	250	W
Operating Junction Temperature	T_J	-40 ~ 150	$^\circ\text{C}$	
Storage Temperature Range	T_{STG}	-40 ~ 150	$^\circ\text{C}$	

Notes :

(1) Repetitive rating : Pulse width limited by maximum junction temperature

Thermal Characteristics

Parameter	Symbol	Value	Unit
Typical Thermal resistance, Junction-to-Case (Per 1/2 Module)	$R_{\theta JC}$ (IGBT)	0.2	K/W
Typical Thermal resistance, Junction-to-Case (Per 1/2 Module)	$R_{\theta JC}$ (DIODE)	0.6	K/W

Electrical Characteristics of the IGBT $T_j=25^\circ\text{C}$, unless otherwise noted

Parameter	Symbol	Test condition	Min.	Typ.	Max.	Unit
OFF						
Collector – Emitter Breakdown Voltage	BV_{CES}	$V_{GE} = 0V, I_C = 1mA$	1200	--	--	V
Zero Gate Voltage Collector Current	I_{CES}	$V_{CE} = 1200V, V_{GE} = 0V$	--	--	1	mA
Gate – Emitter Leakage Current	I_{GES}	$V_{CE} = 0V, V_{GE} = \pm 20V$	--	--	± 100	nA
ON						
Gate – Emitter Threshold Voltage	$V_{GE(TH)}$	$V_{GE} = V_{CE}, I_C = 250\mu A$	4.0	--	7.5	V
		$V_{GE} = V_{CE}, I_C = 150mA$	5.0	--	8.5	V
Collector – Emitter Saturation Voltage	$V_{CE(SAT)}$	$V_{GE} = 15V, I_C = 150A, T_j = 25^\circ\text{C}$	--	2.3	2.8	V
		$V_{GE} = 15V, I_C = 150A, T_j = 150^\circ\text{C}$	--	2.5	3.0	V
DYNAMIC						
Input Capacitance	C_{IES}	$V_{CE} = 25V,$ $V_{GE} = 0V$ $f = 1MHz$	--	20	--	nF
Output Capacitance	C_{OES}		--	980	--	pF
Reverse Transfer Capacitance	C_{RES}		--	450	--	pF
SWITCHING						
Turn-On Delay Time	$t_{d(on)}$	$V_{CC} = 600V, I_C = 150A$ $R_G = 1.1\Omega, V_{GE} = \pm 15V$ Inductive Load, $T_j = 25^\circ\text{C}$	--	85	--	ns
Rise Time	t_r		--	45	--	ns
Turn-Off Delay Time	$t_{d(off)}$		--	340	--	ns
Fall Time	t_f		--	70	--	ns
Turn-On Switching Loss	E_{ON}		--	1.8	--	mJ
Turn-Off Switching Loss	E_{OFF}		--	6.1	--	mJ
Total Switching Loss	E_{TS}	--	7.9	--	mJ	
Turn-On Delay Time	$t_{d(on)}$	$V_{CC} = 600V, I_C = 150A$ $R_G = 1.1\Omega, V_{GE} = \pm 15V$ Inductive Load, $T_j = 150^\circ\text{C}$	--	130	--	ns
Rise Time	t_r		--	65	--	ns
Turn-Off Delay Time	$t_{d(off)}$		--	510	--	ns
Fall Time	t_f		--	100	--	ns
Turn-On Switching Loss	E_{ON}		--	2.6	--	mJ
Turn-Off Switching Loss	E_{OFF}		--	10.7	--	mJ
Total Switching Loss	E_{TS}	--	13.3	--	mJ	
Total Gate Charge	Q_g	$V_{CC} = 600V, I_C = 150A$ $V_{GE} = 15V$	--	1270	--	nC
Gate-Emitter Charge	Q_{ge}		--	220	--	nC
Gate-Collector Charge	Q_{gc}		--	570	--	nC
Short Circuit Withstanding Time	t_{sc}	$V_{CC} = 600V, V_{GE} = 15V, T_j = 150^\circ\text{C}$	10	--	--	μs

Electrical Characteristics of the DIODE $T_j=25^{\circ}\text{C}$, unless otherwise noted

Parameter	Symbol	Test condition	Min.	Typ.	Max.	Unit	
Diode Forward Voltage	V_{FM}	$I_F = 150\text{A}$	$T_j = 25^{\circ}\text{C}$	--	1.8	2.6	V
			$T_j = 150^{\circ}\text{C}$	--	1.9	2.7	
Reverse Recovery Current	I_{rr}	$V_{CC} = 600\text{V}, I_F = 150\text{A}$ $R_G = 1.1\Omega, V_{GE} = \pm 15\text{V}$ Inductive Load	$T_j = 25^{\circ}\text{C}$	--	65	--	A
			$T_j = 150^{\circ}\text{C}$	--	85	--	
Reverse Recovery Charge	Q_{rr}	$V_{CC} = 600\text{V}, I_F = 150\text{A}$ $R_G = 1.1\Omega, V_{GE} = \pm 15\text{V}$ Inductive Load	$T_j = 25^{\circ}\text{C}$	--	13.5	--	μC
			$T_j = 150^{\circ}\text{C}$	--	25.5	--	
Reverse Recovery Energy	E_{rr}	$V_{CC} = 600\text{V}, I_F = 150\text{A}$ $R_G = 1.1\Omega, V_{GE} = \pm 15\text{V}$ Inductive Load	$T_j = 25^{\circ}\text{C}$	--	4.3	--	mJ
			$T_j = 150^{\circ}\text{C}$	--	6.7	--	

Characteristics of the Module

Parameter	Symbol	Test condition	Min.	Typ.	Max.	Unit
Isolation Voltage	V_{ISO}	RMS, $f=50\text{Hz}$, $t=1$ minutes	--	2.5	--	kV
Terminal mounting torque (M5)	--		--	3.0	--	N.m
Weight	--		--	170	--	g

IGBT Characteristics

Fig. 1 Output characteristics

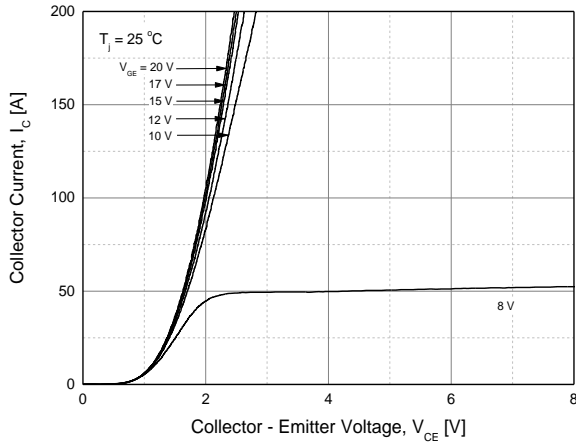

Fig. 2 Saturation voltage characteristics

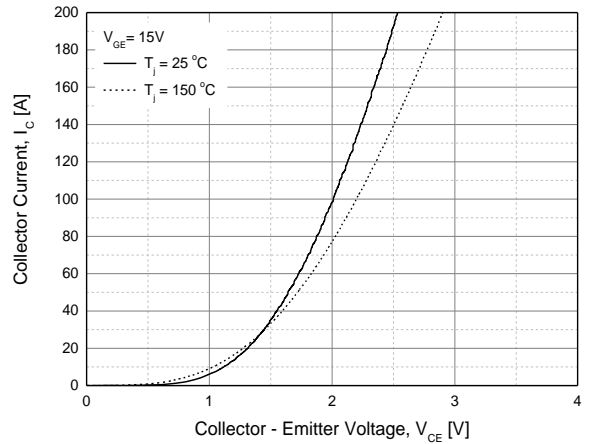

Fig. 3 Turn-on time vs. gate resistor

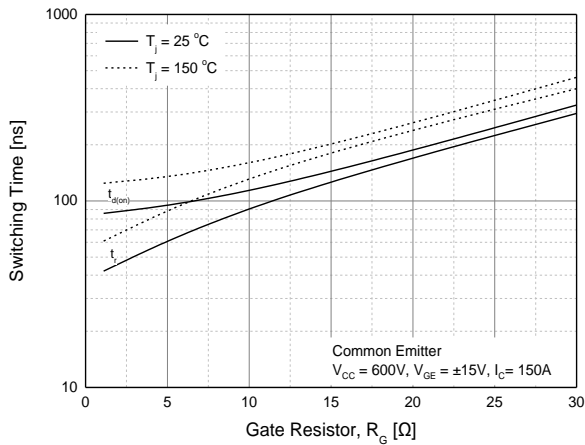

Fig. 4 Turn-off time vs. gate resistor

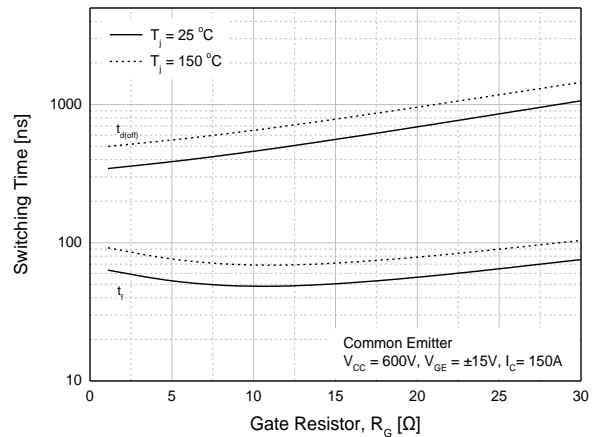

Fig. 5 Switching loss vs. gate resistor

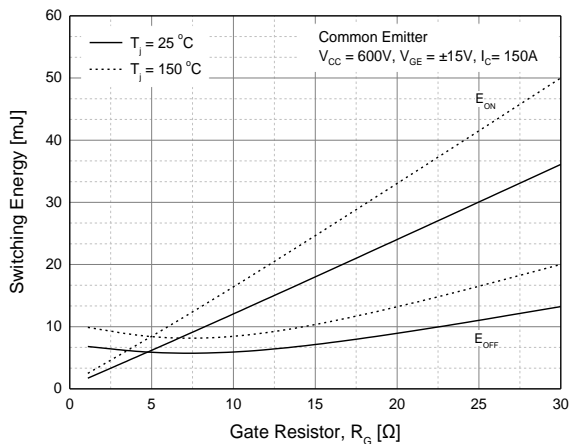
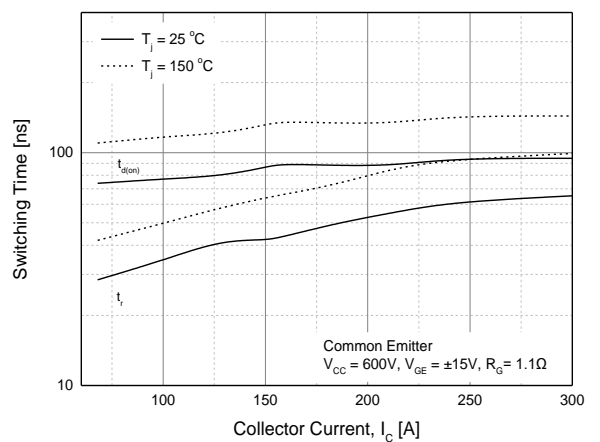

Fig. 6 Turn-on time vs. collector current



IGBT Characteristics

Fig. 7 Turn-off time vs. collector current

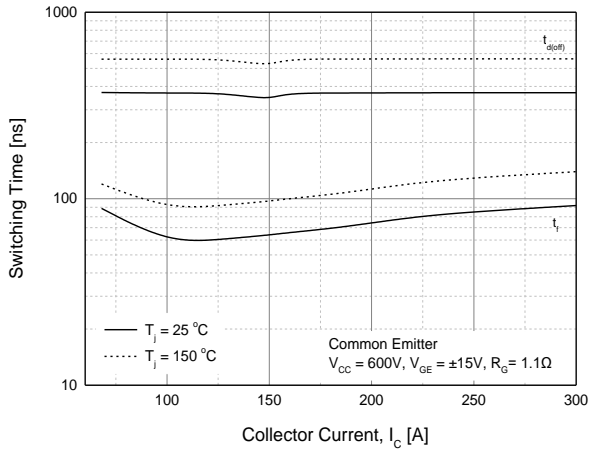

Fig. 8 Switching loss vs. collector current

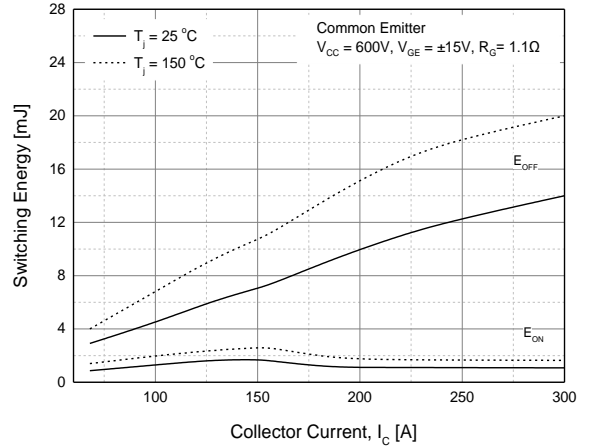

Fig. 9 Gate charge characteristics

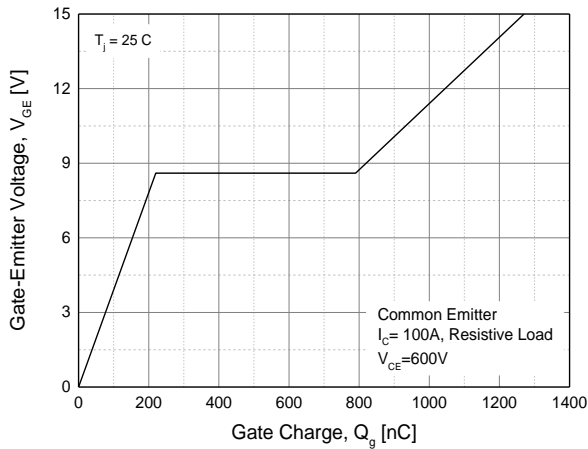

Fig. 10 Transient thermal impedance of IGBT

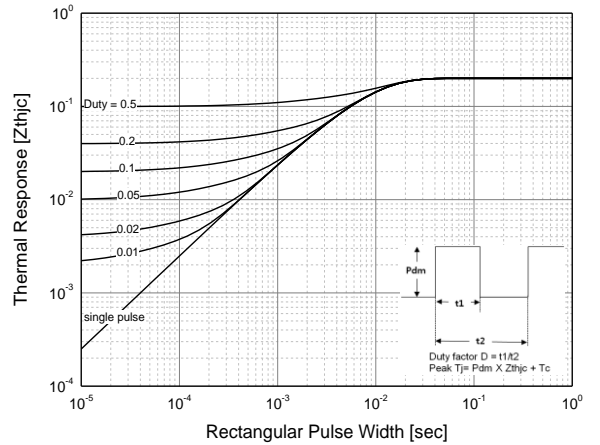

Fig. 11 SOA

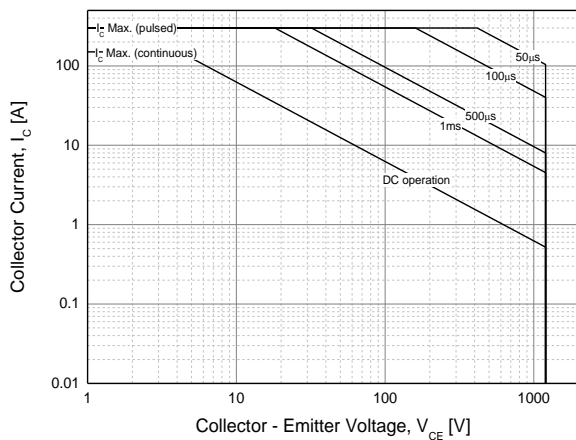
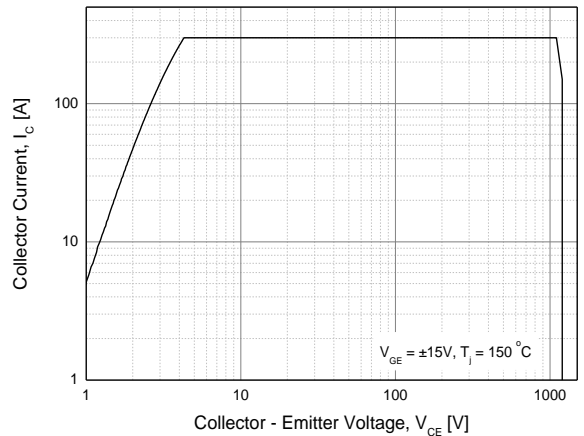
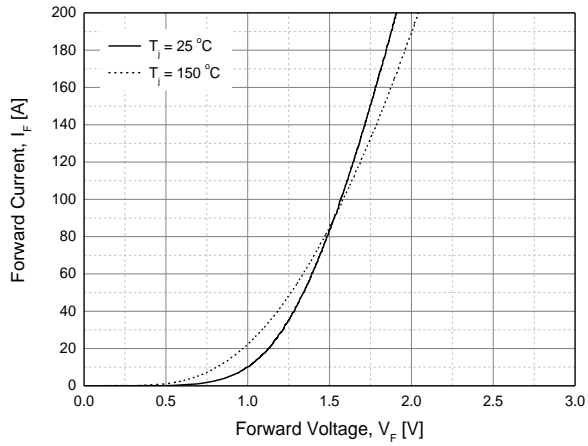

Fig. 12 RBSOA



Diode Characteristics

Fig. 13 Conduction characteristics of Diode



Package Outline (Dimension in mm)

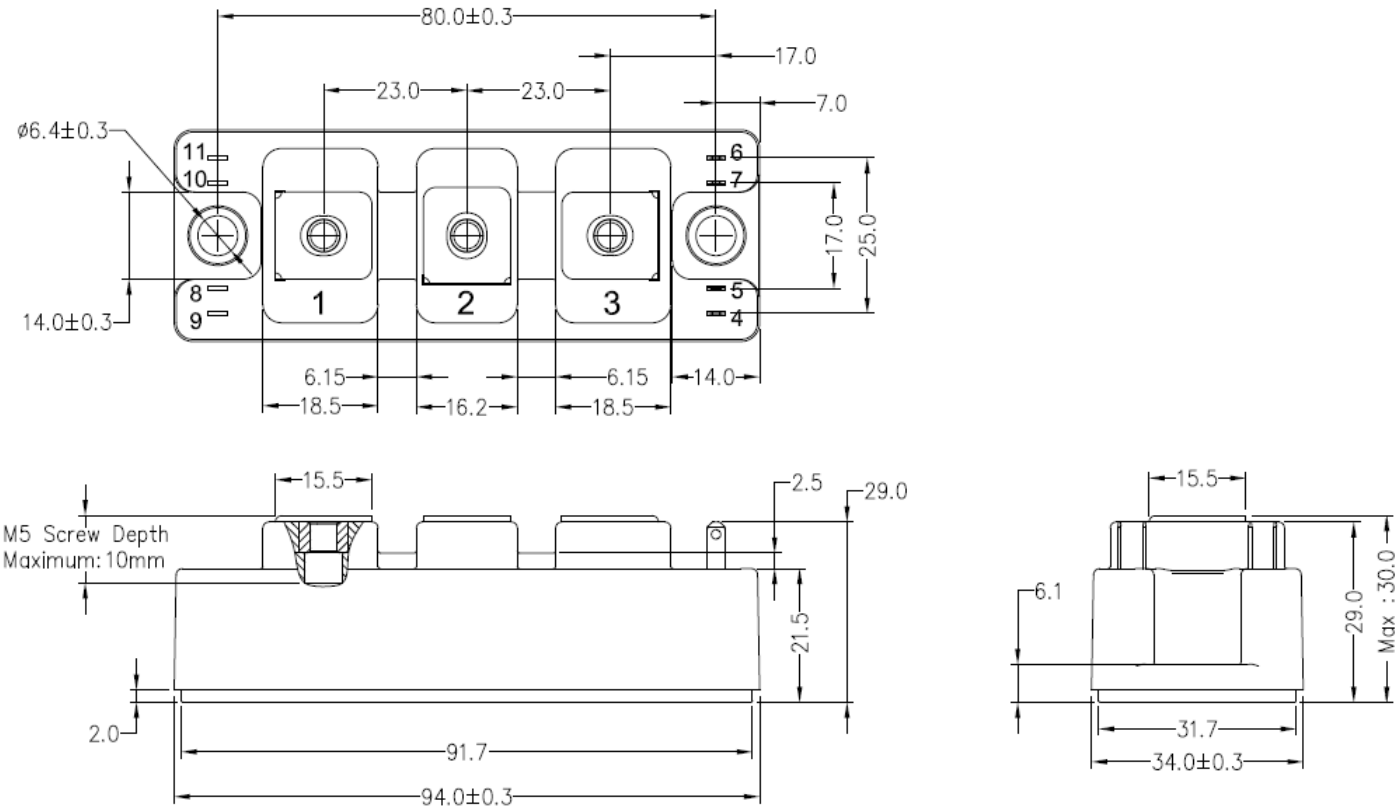

Disclaimer

TRinno technology reserves the right to make changes without notice to products herein to improve reliability, performance, or design. The information given in this document is believed to be accurate and reliable. However, it shall in no event be regarded as a guarantee of conditions and characteristics. With respect to any information regarding the application of the device, TRinno technology hereby disclaims any and all warranties and liabilities of any kind, including without limitation, warranties of non-infringement of patent rights of any third party.